

# CENTRAL MACHINERY

®

## 4 TON ELECTRIC LOG SPLITTER

Model 93815

### ASSEMBLY AND OPERATING INSTRUCTIONS



Due to continuing improvements, actual product may differ slightly from the product described herein.



3491 Mission Oaks Blvd., Camarillo, CA 93011  
Visit our Web site at: <http://www.harborfreight.com>

Copyright © 2006 by Harbor Freight Tools®. All rights reserved. No portion of this manual or any artwork contained herein may be reproduced in any shape or form without the express written consent of Harbor Freight Tools.

For technical questions, please call 1-800-444-3353.

## PRODUCT SPECIFICATIONS

Item	Description
Electric Motor	2 HP, 110 V, 60 Hz, Single Phase, 1150 Watts
Power Cord	14 AWG x 3C, Double Insulated
Measured Amperage	8.1 with no load 10 with load 30 at start-up
Maximum Force	4 Tons (8,000 Lbs.)
Log Size Capacity	20" L x 10" D
Wedge Size	5"
Ram Travel	14-1/2"
Ram Diameter	1.75"
Hydraulic Oil Capacity	3.2 Quarts
Overall Dimensions	30-1/2" L x 12" W x 19-1/4" H
Weight	97 Lbs.

## SAVE THIS MANUAL

You will need this manual for the safety warnings and precautions, assembly, operating, inspection, maintenance and cleaning procedures, parts list and assembly diagram. Keep your invoice with this manual. Write the invoice number on the inside of the front cover. Keep this manual and invoice in a safe and dry place for future reference.

## GENERAL SAFETY RULES



**WARNING!**

### **READ AND UNDERSTAND ALL INSTRUCTIONS**

**Failure to follow all instructions listed below may result in electric shock, fire, and/or serious injury.**

**SAVE THESE INSTRUCTIONS**

## WORK AREA

1. **Keep your work area clean and well lit.** Cluttered and dark areas invite accidents.
2. **Do not operate power tools in explosive atmospheres, such as in the presence of flammable liquids, gases, or dust.** Power tools create sparks which may ignite the dust or fumes.
3. **Keep bystanders, children, and visitors away while operating a splitter tool.** Distractions can cause you to lose control. Protect others in the work area from debris such as chips and sparks. Provide barriers or shields as needed.

## ELECTRICAL SAFETY

4. **Grounded tools must be plugged into an outlet properly installed and grounded in accordance with all codes and ordinances. Never remove the grounding prong or modify the plug in any way. Do not use any adapter plugs. Check with a qualified electrician if you are in doubt as to whether the outlet is properly grounded.** If the tools should electrically malfunction or break down, grounding provides a low resistance path to carry electricity away from the user.
5. **Double insulated tools are equipped with a polarized plug (one blade is wider than the other). This plug will fit in a polarized outlet only one way. If the plug does not fit fully in the outlet, reverse the plug. If it still does not fit, contact a qualified electrician to install a polarized outlet. Do not change the plug in any way.** Double insulation  eliminates the need for the three wire grounded power cord and grounded power supply system.
6. **Avoid body contact with grounded surfaces such as pipes, radiators, ranges, and refrigerators.** There is an increased risk of electric shock if your body is grounded.
7. **Do not expose splitter to rain or wet conditions.** Water entering the splitter will increase the risk of electric shock.
8. **Do not abuse the Power Cord. Never use the Power Cord to pull the Plug from an outlet. Keep the Power Cord away from heat, oil, sharp edges, or moving parts. Replace damaged Power Cords immediately.** Damaged Power Cords increase the risk of electric shock.
9. **When operating the splitter outside, use an outdoor extension cord marked “W-A” or “W”.** These extension cords are rated for outdoor use, and reduce the risk of electric shock.

## PERSONAL SAFETY

10. **Stay alert. Watch what you are doing, and use common sense when operating the splitter. Do not use the splitter while tired or under the influence of drugs, alcohol, or medication.** A moment of inattention while operating the splitter may result in serious personal injury.
11. **Dress properly. Do not wear loose clothing or jewelry. Contain long hair. Keep your hair, clothing, and gloves away from moving parts.** Loose clothes, jewelry, or long hair can be caught in moving parts.

12. **Avoid accidental starting. Be sure the Power Switch is off before plugging in.** Plugging in the splitter with the Power Switch on, invites accidents.
13. **Remove adjusting keys or wrenches before turning the splitter on.** A wrench or a key that is left attached to a rotating part of the power tool may result in personal injury.
14. **Do not overreach. Keep proper footing and balance at all times.** Proper footing and balance enables better control of the splitter in unexpected situations.
15. **Use safety equipment. Always wear eye protection.** Dust mask, non-skid safety shoes, hard hat, or hearing protection must be used for appropriate conditions.

#### TOOL USE AND CARE

16. **Use clamps (not included) or other practical ways to secure and support the workpiece to a stable platform.** Holding the work by hand or against your body is unstable and may lead to loss of control.
17. **Do not force the splitter. Use the correct splitter for your application.** The correct splitter will do the job better and safer at the rate for which it is designed.
18. **Do not use the power tool if the Power Switch does not turn it on or off.** Any tool that cannot be controlled with the Power Switch is dangerous and must be replaced.
19. **Disconnect the Power Cord Plug from the power source before making any adjustments, changing accessories, or storing the splitter.** Such preventive safety measures reduce the risk of starting the tool accidentally.
20. **Store idle splitter out of reach of children and other untrained persons.** The splitter is dangerous in the hands of untrained users.
21. **Maintain splitter with care. Keep cutting tools sharp and clean.** Properly maintained splitter with a sharp cutting edge are less likely to bind and are easier to control. Do not use a damaged splitter. Tag damaged tools "Do not use" until repaired.
22. **Check for misalignment or binding of moving parts, breakage of parts, and any other condition that may affect the splitter's operation. If damaged, have the splitter serviced before using.** Many accidents are caused by poorly maintained tools.

23. **Use only accessories that are recommended by the manufacturer for your model.** Accessories that may be suitable for one tool may become hazardous when used on another tool.

### SERVICE

24. **Log Splitter service must be performed only by qualified repair personnel.** Service or maintenance performed by unqualified personnel could result in a risk of injury.
25. **When servicing the Log Splitter, use only identical replacement parts. Follow instructions in the “*Inspection, Maintenance, And Cleaning*” section of this manual.** Use of unauthorized parts or failure to follow maintenance instructions may create a risk of electric shock or injury.

## SPECIFIC SAFETY RULES

Using this powerful tool may create special hazards.  
Take particular care to safeguard yourself and those around you.

**Hydraulic systems. Never operate this tool if there is a hazard presented by hydraulic fluid.** Before using the Log Splitter, check for hydraulic leaks. Be sure the tool and your work area are clean and free of oil spills. Hydraulic fluid can create hazards, causing you to slip and fall, your hands to slip while using the machine, or fire hazard.

**Electrical Safety. Never operate this tool if there is an electrical hazard.** Never operate an electrical tool in wet conditions. Never operate this tool with an improper electrical cord or extension cord. Never operate this tool unless you are plugged into a properly grounded outlet, which supplies 110-120Volts, and is protected by a 30 Amp circuit breaker.

**Physical Hazards. Log Splitting creates special physical hazards.** Never operate this tool unless you are wearing proper safety gloves, hard-toed shoes, long pants and a shirt with sleeves and ANSI-approved eye protection. Be careful of the splinters that will be produced, to avoid puncture injury and potential jamming of the tool. Never try to split logs which are too large or small to fit properly within the tool. Never attempt to split logs containing nails, wire or other debris. Clean up as you work; accumulated split wood and wood chips can create a hazardous work environment. Never continue to work in a cluttered work area which may cause you to slip, trip or fall. Keep onlookers away from this tool, and never allow unauthorized persons to operate this tool.

1. **Maintain labels and nameplates on the Log Splitter.** These carry important information. If unreadable or missing, contact Harbor Freight Tools for a replacement.

2. **Always wear safety impact eye goggles and heavy work gloves when using the splitter.** Using personal safety devices reduce the risk for injury. Safety impact eye goggles and heavy work gloves are available from Harbor Freight Tools.
3. **Maintain a safe working environment.** Keep the work area well lit. Make sure there is adequate surrounding workspace. Always keep the work area free of obstructions, grease, oil, trash, and other debris. Do not use the splitter in areas near flammable chemicals, dusts, and vapors. Do not use this product in a damp or wet location.
4. **Make sure to read and understand all instructions and safety precautions as outlined in this instruction manual.**
5. **Always keep the extension cord away from moving parts on the tool.**
6. **Avoid unintentional starting.** Make sure you are prepared to begin work before turning on the splitter.
7. **Do not force the splitter.** This tool will do the work better and safer at the speed and capacity for which it was designed.
8. **Never leave the splitter unattended when it is plugged into an electrical outlet.** Turn off the splitter, and unplug it from its electrical outlet before leaving.
9. **Always unplug the splitter from its electrical outlet before performing and inspection, maintenance, or cleaning procedures.**
10. **WARNING!** Some dust created by power sanding, sawing, grinding, drilling, and other construction activities, contain chemicals known (to the State of California) to cause cancer, birth defects or other reproductive harm. Some examples of these chemicals are: lead from lead-based paints, crystalline silica from bricks and cement or other masonry products, arsenic and chromium from chemically treated lumber. Your risk from these exposures varies, depending on how often you do this type of work. To reduce your exposure to these chemicals: work in a well ventilated area, and work with approved safety equipment, such as those dust masks that are specially designed to filter out microscopic particles.  
*(California Health & Safety Code § 25249.5, et seq.)*
11. **WARNING!** People with pacemakers should consult their physician(s) before using this product. Operation of electrical equipment in close proximity to a heart pacemaker could cause interference or failure of the pacemaker.

## GROUNDING

### WARNING!

Improperly connecting the grounding wire can result in the risk of electric shock. Check with a qualified electrician if you are in doubt as to whether the outlet is properly grounded. Do not modify the power cord plug provided with the tool. Never remove the grounding prong from the plug. Do not use the tool if the power cord or plug is damaged. If damaged, have it repaired by a service facility before use. If the plug will not fit the outlet, have a proper outlet installed by a qualified electrician.

### GROUNDING TOOLS: TOOLS WITH THREE PRONG PLUGS

1. Tools marked with “Grounding Required” have a three wire cord and three prong grounding plug. The plug must be connected to a properly grounded outlet. If the tool should electrically malfunction or break down, grounding provides a low resistance path to carry electricity away from the user, reducing the risk of electric shock. **(See Figure A.)**
2. The grounding prong in the plug is connected through the green wire inside the cord to the grounding system in the tool. The green wire in the cord must be the only wire connected to the tool’s grounding system and must never be attached to an electrically “live” terminal. **(See Figure A.)**
3. Your tool must be plugged into an appropriate outlet, properly installed and grounded in accordance with all codes and ordinances. The plug and outlet should look like those in the following illustration. **(See Figure A.)**

Note: The Log Splitter has a 3-prong electrical plug.

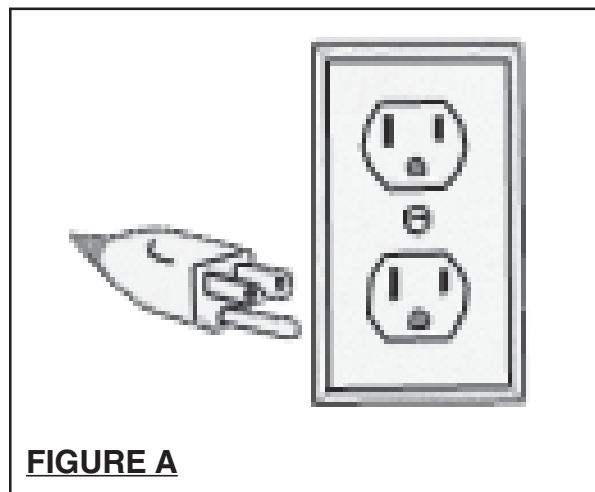

**FIGURE A**

## DOUBLE INSULATED TOOLS: TOOLS WITH TWO PRONG PLUGS

4. Tools marked “Double Insulated” do not require grounding. They have a special double insulation system which satisfies OSHA requirements and complies with the applicable standards of Underwriters Laboratories, Inc., the Canadian Standard Association, and the National Electrical Code. **(See Figure B.)**
5. Double insulated tools may be used in either of the 120 volt outlets shown in the following illustration. **(See Figure B.)**

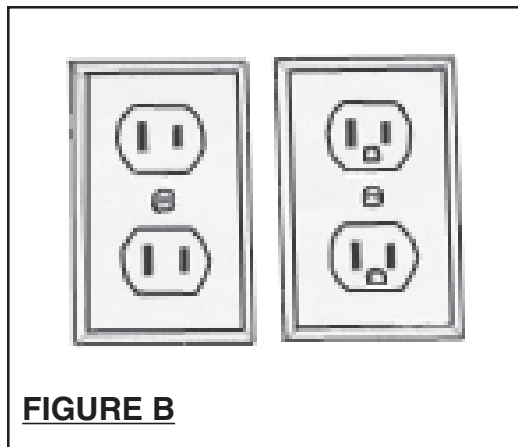

## EXTENSION CORDS

1. **Grounded** tools require a three wire extension cord. **Double Insulated** tools can use either a two or three wire extension cord.
2. As the distance from the supply outlet increases, you must use a heavier gauge extension cord. Using extension cords with inadequately sized wire causes a serious drop in voltage, resulting in loss of power and possible tool damage. **(See Figure C, next page.)**
3. The smaller the gauge number of the wire, the greater the capacity of the cord. For example, a 14 gauge cord can carry a higher current than a 16 gauge cord. **(See Figure C.)**
4. When using more than one extension cord to make up the total length, make sure each cord contains at least the minimum wire size required. **(See Figure C.)**
5. If you are using one extension cord for more than one tool, add the nameplate amperes and use the sum to determine the required minimum cord size. **(See Figure C.)**





6. If you are using an extension cord outdoors, make sure it is marked with the suffix “W-A” (“W” in Canada) to indicate it is acceptable for outdoor use.
7. Make sure your extension cord is properly wired and in good electrical condition. Always replace a damaged extension cord or have it repaired by a qualified electrician before using it.
8. Protect your extension cords from sharp objects, excessive heat, and damp or wet areas.

<b>RECOMMENDED MINIMUM WIRE GAUGE FOR EXTENSION CORDS*</b> <b>(120 VOLT)</b>					
<b>NAMEPLATE AMPERES (At Full Load)</b>	<b>EXTENSION CORD LENGTH</b>				
	<b>25 Feet</b>	<b>50 Feet</b>	<b>75 Feet</b>	<b>100 Feet</b>	<b>150 Feet</b>
<b>0 – 2.0</b>	<b>18</b>	<b>18</b>	<b>18</b>	<b>18</b>	<b>16</b>
<b>2.1 – 3.4</b>	<b>18</b>	<b>18</b>	<b>18</b>	<b>16</b>	<b>14</b>
<b>3.5 – 5.0</b>	<b>18</b>	<b>18</b>	<b>16</b>	<b>14</b>	<b>12</b>
<b>5.1 – 7.0</b>	<b>18</b>	<b>16</b>	<b>14</b>	<b>12</b>	<b>12</b>
<b>7.1 – 12.0</b>	<b>18</b>	<b>14</b>	<b>12</b>	<b>10</b>	<b>-</b>
<b>12.1 – 16.0</b>	<b>14</b>	<b>12</b>	<b>10</b>	<b>-</b>	<b>-</b>
<b>16.1 – 20.0</b>	<b>12</b>	<b>10</b>	<b>-</b>	<b>-</b>	<b>-</b>

**FIGURE C** \* Based on limiting the line voltage drop to five volts at 150% of the rated amperes.

## SYMBOLOLOGY

	Double Insulated
	Canadian Standards Association
	Underwriters Laboratories, Inc.
<b>V ~</b>	Volts Alternating Current
<b>A</b>	Amperes
<b>n<sub>o</sub>xxxx/min.</b>	No Load Revolutions per Minute (RPM)

## UNPACKING

When unpacking, check to make sure all the parts shown on the **Parts List on page 14** are included. If any parts are missing or broken, please call Harbor Freight Tools at the number shown on the cover of this manual as soon as possible.

## ASSEMBLY

The only assembly required is as follows: Screw Handle A (D Below) into Handle B (E Below). The Log Splitter is ready for use, after reading and adhering to all Safety Warnings and Cautions, and Operation and Maintenance instructions provided in this manual.

### Product Features



Figure D

- A Wedge
- B Log Guiding Plates
- C Log Pusher/Lifting Handle
- D Handle A
- E Handle Shaft
- F Shield
- G Pump Cover
- H Main Body
- I Wheel Stand Assembly
- J Motor Assembly
- K Motor Start Switch
- L Wheels

## OPERATING INSTRUCTIONS

**NOTE:** For additional information regarding the parts listed in the following pages, refer to the **Assembly Diagram on page 15**.

*Please Refer to Figure D on page 10 in following these instructions.*

1. **Plan your work site.** Work safely and save effort by planning your work before hand. Have your logs positioned where they can be easily reached. Have a site located to stack the split wood or load it onto a nearby truck or other carrier.
2. **Prepare the logs for splitting.** This splitter accomodates logs up to 20” in length, and 10” in diameter. When cutting up limbs and large sections, do not cut sections any longer than 20”. Do not attempt to split green logs. Dry, seasoned logs split much more easily, and will not jam as frequently as green wood.
3. **Route the power cord.** Locate an appropriate power outlet, and secure an adequate extension cord, if needed. Route the cord from the splitter to the power source in a way that safeguards against tripping on the cord, or the cord becoming damaged during the work session. Be sure to avoid wet conditions.
4. **Check level of hydraulic oil.** Before first use, and before each subsequent use, check to make sure the Log Splitter is filled with hydraulic oil (see “Checking/ Changing Hydraulic Oil” section on page 12).
5. **Position Splitter Securely.** Be sure the Splitter is positioned firmly on level, solid ground. If necessary, block the Wheels (25) with wedges to prevent them from rolling.
6. **Open the Air Bleed. Loosen the Bleed Screw (14)** - [located on the Front Cover (15) in the upper right-hand corner] **3-4 turns whenever the splitter is being used.** Retighten this screw when you are finished.
7. **Place log onto Splitter.** Place the log onto the splitter, lengthwise and lying flat on the Main Body (47A). The log should lie flat on the Splitter, and be cradled by the Guide (46A). *Never attempt to split a log at an angle.* Be sure the Wedge and Log Pusher (49A) will contact the log squarely on the ends.
8. **Two hand operation.** When it is safe to do so, **depress the Switch (36) with one hand.** Wait a few seconds as the motor spins up and creates pressure in the Hydraulic pump. Then, **when it is safe to do so, depress the Handle A (61).** The Log Pusher (49A) will compress the log, pushing it against the Wedge, splitting the log. Once the log is split, **release both the Switch (36) and Handle A (61); this will allow the Log Pusher (49A) to retract.**

**Warning:** If the log does not split immediately, do not force it by maintaining the thrust for more than a few seconds. This can damage the tool. It is better to try re-positioning the log on the Log Splitter, or setting the log aside.

9. **Stack as you work.** This will provide a safer work area, by keeping it uncluttered, and avoid the danger of tripping, or damaging the power cord.
10. **Remember to retighten the Bleed Screw (14) when you are finished.**

## INSPECTION, MAINTENANCE, AND CLEANING

**Note:** Only a qualified service technician should repair or service the internal hydraulic system of this unit.

1. **WARNING!** Make sure the Switch (36) of the splitter is in its “OFF” position and that the tool is unplugged from its electrical outlet before performing any inspection, maintenance, or cleaning procedures.
2. **BEFORE EACH USE,** inspect the general condition of the splitter. Check for loose screws, misalignment or binding of moving parts, cracked or broken parts, damaged electrical wiring, and any other condition that may affect its safe operation. If abnormal noise or vibration occurs, have the problem corrected before further use. **Do not use damaged equipment.**

## MAINTENANCE

**WARNING:** Before Performing Any Maintenance, Unplug the Tool from the Power Source!

### CHECKING/CHANGING THE HYDRAULIC OIL

Please refer to Figure E on this page, and Parts Diagram on page 15.

1. Make sure the LOG PUSHER (49A) is fully retracted.
2. Carefully unscrew the OIL GAUGE (10) and remove it completely.
3. Position a container under the log splitter that will hold at least 3.2 quarts of oil. Then tilt the machine to empty the oil into the container.
4. Tilt the Log Splitter the other way, with the Oil Fill / Drain Port up. Using a clean funnel, pour in 3.2 quarts of Hydraulic Oil. (Be sure to use only clean, high quality hydraulic oil specifically made for this purpose.)
5. Clean the OIL GAUGE (10), and carefully insert it to make sure the oil level is between the two marks on the dipstick.
6. Clean the OIL GAUGE (10), OIL SEAL (12), and O-RING OIL SEAL (11) thoroughly, and re-install. Be careful not to damage the threads of the aluminum FRONT COVER (15).

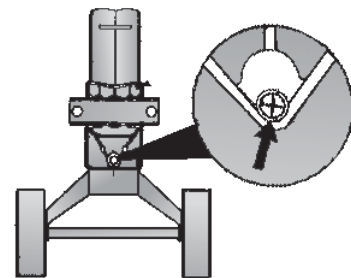

Figure E  
Oil Fill/Drain Port

**Warning: Be sure to dispose of the dirty oil properly. Take it to your local waste oil recycling center. Never dump it on the ground or mix it with trash.**

### **Refilling the Hydraulic Oil**

1. Periodically check the level of the oil. It must be between the two notches on the lower end of the Dip Stick. If the oil level is low, refill using a recommended oil.

### **Sharpening the Wedge**

1. After long periods of operation, and when required; sharpen the wedge using a fine-toothed file and carefully removing any burrs or flat spots on the edge.

### **HOW TO FREE A JAMMED LOG**

1. Release both controls, so that the LOG PUSHER (49A) will be fully retracted.
2. Insert a triangular wedge of wood under the log, and activate the log pusher to push the wedge under the jammed log.
3. Repeat this process using progressively larger wedges, until the jammed log is freed. **Warning:** Never hammer on the jammed log, or place your hands near the log when attempting to free it.

## **PLEASE READ THE FOLLOWING CAREFULLY**

THE MANUFACTURER AND/OR DISTRIBUTOR HAS PROVIDED THE PARTS LIST AND ASSEMBLY DIAGRAM IN THIS MANUAL AS A REFERENCE TOOL ONLY. NEITHER THE MANUFACTURER OR DISTRIBUTOR MAKES ANY REPRESENTATION OR WARRANTY OF ANY KIND TO THE BUYER THAT HE OR SHE IS QUALIFIED TO MAKE ANY REPAIRS TO THE PRODUCT, OR THAT HE OR SHE IS QUALIFIED TO REPLACE ANY PARTS OF THE PRODUCT. IN FACT, THE MANUFACTURER AND/OR DISTRIBUTOR EXPRESSLY STATES THAT ALL REPAIRS AND PARTS REPLACEMENTS SHOULD BE UNDERTAKEN BY CERTIFIED AND LICENSED TECHNICIANS, AND NOT BY THE BUYER. THE BUYER ASSUMES ALL RISK AND LIABILITY ARISING OUT OF HIS OR HER REPAIRS TO THE ORIGINAL PRODUCT OR REPLACEMENT PARTS THERETO, OR ARISING OUT OF HIS OR HER INSTALLATION OF REPLACEMENT PARTS THERETO.

## PARTS LIST

Part No.	Description	Q'ty	Part No.	Description	Q'ty
1	Nut M14 Self-lock	2	43	Outlet Box	1
2	Hex Nut M14	4	44	Motor	2
3	Piston Ram	1	45	Hex Bolt M8x10	2
4	Spring	1	46A	Guide	2
5	O Ring Oil Seal 25x3.55	1	47A	Main Body	1
6	Piston	1	48	ABS Support Plate	2
7	O Ring Oil Seal 43.5x3.5	1	49A	Log Pusher	1
8	Oil Seal	1	50A	Pump Cover	1
9	Cylinder	1	51	Hex Bolt M6x14	2
10	Oil Gauge	1	52	Flat Washer 6	2
11	O Ring Oil Seal 10.6x1.8	1	53	Strengthened Bolt M8x30	3
12	Oil Seal	1	54	O Ring Oil Seal 55x3.1	1
13	O Ring Oil Seal 30x2.65	1	55	Pump Cover Connector	1
14	Bleed Screw M3x10	1	56	O Ring Oil Seal 10x2.65	2
15	Front Cover	1	57	Inner Hex Screw M6x10	1
16A	Two Head Bolt 789	2	58	Torque Spring	1
17A	Two Head Bolt 805	2	59	Handle Seat	1
18	Screw M8	6	60	Handle Rod	1
19	Flat Washer 8	27	61	Handle A	1
20	Spring Washer 8	19	62	Handle Sleeve	1
21	Hex Bolt M8x25	6	63	Valve	1
22A	Wheel Stand Assembly	1	64	Copper Washer 10	4
23	Wheel Side Cover	2	65	Compound Cap Screw M10	4
24	Shaft Circlip 15	2	66	Nut M10	2
25	Wheel	2	67	Shield	1
26	Hex Bolt M8x16	6	68	Flat Washer 10	2
27	Electric Cord	1	69	Spin Pin 2.5x4	2
28	Bushing	1	70	O Ring Seal 46.2x1.8	2
29	Bushing Screw	1	71	Gear Box	1
30	Cord Clamp	1	72	Round Pin 8x25	2
31	Cross Screw ST3.5x14	8	73	Shaft Circlip	2
32	Capacitor Stand	1	74	Gear Shaft	1
33	Cross Screw M4x8	1	75	Spin Ball 2.5	1
34	Wire Pole	1	76	Gear	2
35	Cross Screw M4x12	2	77	Oil Pump Sleeve	4
36	Switch	1	78	Oil Pump Cover	1
37	Switch Holder	1	79	Strengthened Bolt M8x55	6
38	Water-proof Cover	1	80A	Oil Pipe Assembly	2
39	Lock Washer 8	1	81	Cross Screw M6x20	2
40	Capacitor	1	82	Carrying Handle	1
41	Water-proof Rubber Cover	1	83	Screw M6	2
42	Outlet Box Cover	1			

# ASSEMBLY DIAGRAM

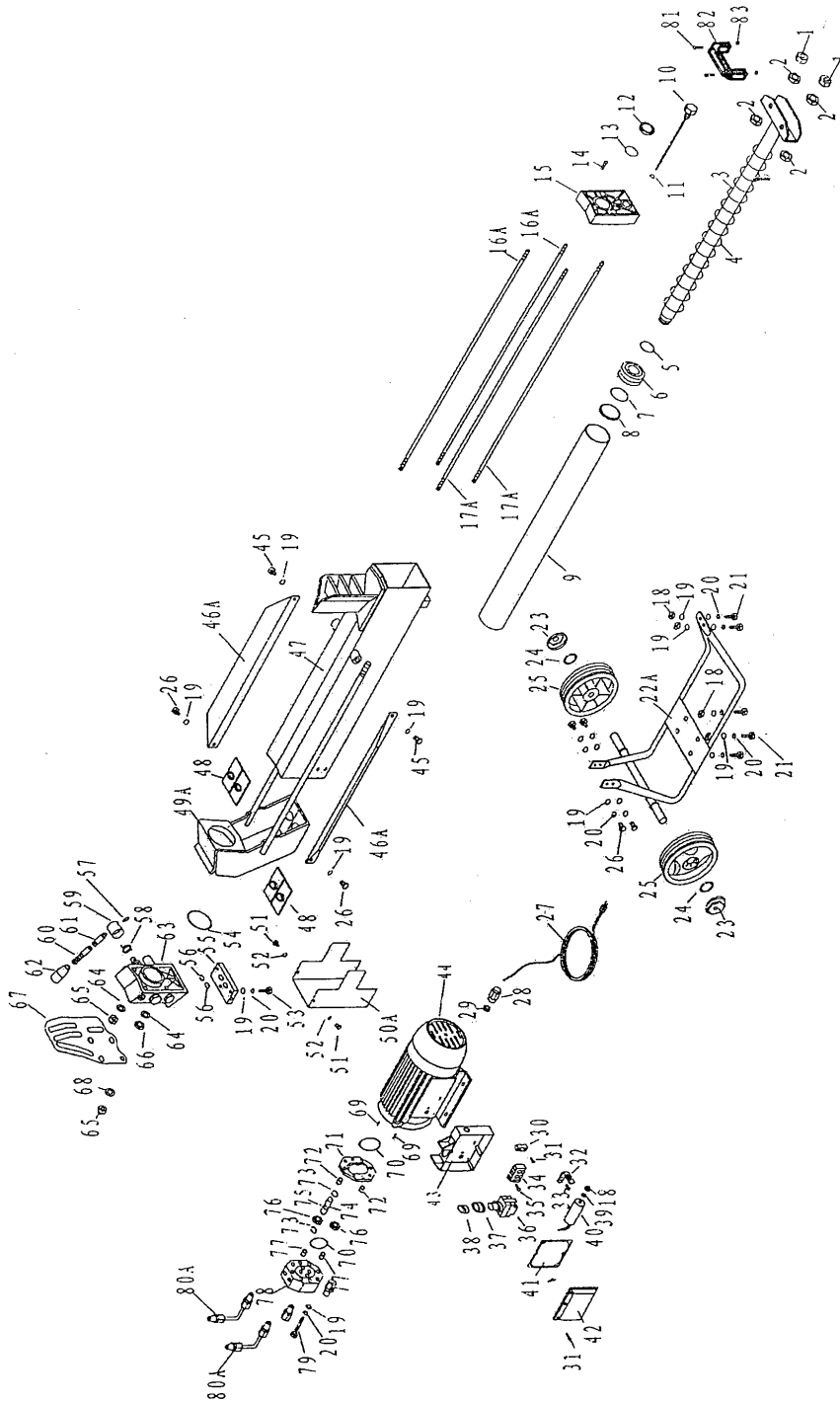

**NOTE:**

Some parts are listed and shown for illustration purposes only, and are not available individually as replacement parts.

## WARRANTY

### **CENTRAL MACHINERY**®

#### ***LIMITED 90 DAY WARRANTY***

Harbor Freight Tools Co. makes every effort to assure that its products meet high quality and durability standards, and warrants to the original purchaser that this product is free from defects in materials and workmanship for the period of ninety days from the date of purchase. This warranty does not apply to damage due directly or indirectly, to misuse, abuse, negligence or accidents, repairs or alterations outside our facilities, or to lack of maintenance. We shall in no event be liable for death, injuries to persons or property, or for incidental, contingent, special or consequential damages arising from the use of our product. Some states do not allow the exclusion or limitation of incidental or consequential damages, so the above limitation of exclusion may not apply to you. **THIS WARRANTY IS EXPRESSLY IN LIEU OF ALL OTHER WARRANTIES, EXPRESS OR IMPLIED, INCLUDING THE WARRANTIES OF MERCHANTABILITY AND FITNESS.**

To take advantage of this warranty, the product or part must be returned to us with transportation charges prepaid. Proof of purchase date and an explanation of the complaint must accompany the merchandise. If our inspection verifies the defect, we will either repair or replace the product at our election or we may elect to refund the purchase price if we cannot readily and quickly provide you with a replacement. We will return repaired products at our expense, but if we determine there is no defect, or that the defect resulted from causes not within the scope of our warranty, then you must bear the cost of returning the product.

This warranty gives you specific legal rights and you may also have other rights which vary from state to state.

**3491 Mission Oaks Blvd. • PO Box 6009 • Camarillo, CA 93011 • (800) 444-3353**